

Specifications

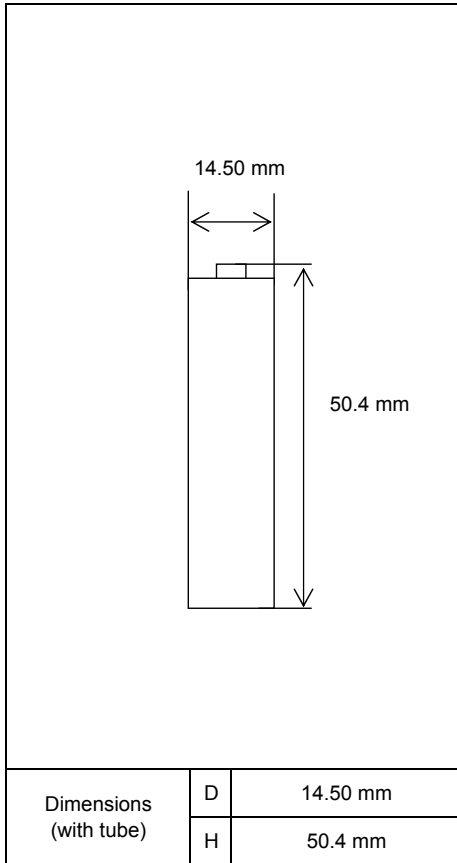

Type : Nickel-Metal Hydride Battery		Size : AA Consumer Type
Capacity ¹⁾	Typical	2550mAh
	Minimum	2450mAh
Nominal Voltage		1.2V
Charging Current x Time	Fast Charge ²⁾	2550mA × 1.1h
Ambient Temp.	Charge Condition	Fast Charge ²⁾
	Discharge Condition	0°C - 40°C
	Less than 90days	0°C - 50°C
	Less than 1year	-20°C - 40°C
Internal Impedance ³⁾ (after discharge to E.V.=1.0V)		Approx. 25mΩ (at 1KHz)
Weight ⁴⁾		Approx. 30 g
Size ⁴⁾ : (Diameter) x (Height)		φ : 14.5mm X H: 50.4mm

- 1) Single cell capacity under the following condition.
Charge : 250mA x 16h, Discharge : 500mA (E.V.=1.0V) at 25deg.C
- 2) Use recommended charging system.
- 3) After a few charge and discharge cycles under the above 1) condition.
- 4) With Label.

Typical Characteristics

Charge

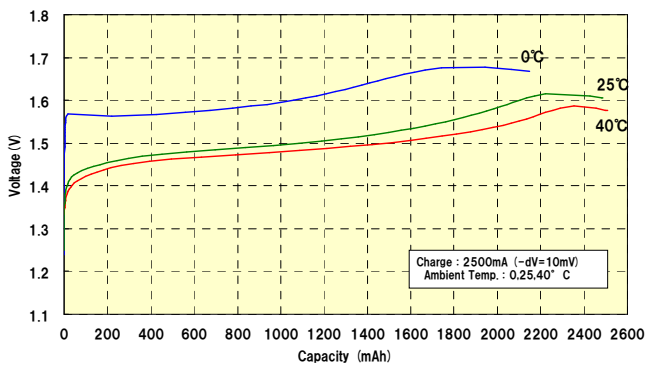

Discharge

